



DESIGN SECURITY DOORS





LA PROTEZIONE DELLA TUA CASA È UN BISOGNO PRIMARIO. SICUREZZA, TRANQUILLITÀ E RISERVATEZZA SONO ELEMENTI INDISPENSABILI.

SENTIRSI BENE E PROTETTI IN CASA PROPRIA MIGLIORA LA QUALITÀ DELLA TUA VITA.

Home protection is a primary need. Security, privacy, tranquility are basic elements. Feeling good and protected at home is part your quality life.

La proteccion de tu casa es una necesidad primaria asi como seguridad, tranquilidad y reserva. Tu vida es mejor si tu te sientes seguro en tu casa.

La protection de la maison est un besoin essentielle. Sureté, tranquillité, discrétion sont des éléments indispensables. Se sentir bien et protégé dans sa propre maison fait partie de la qualité de la vie.



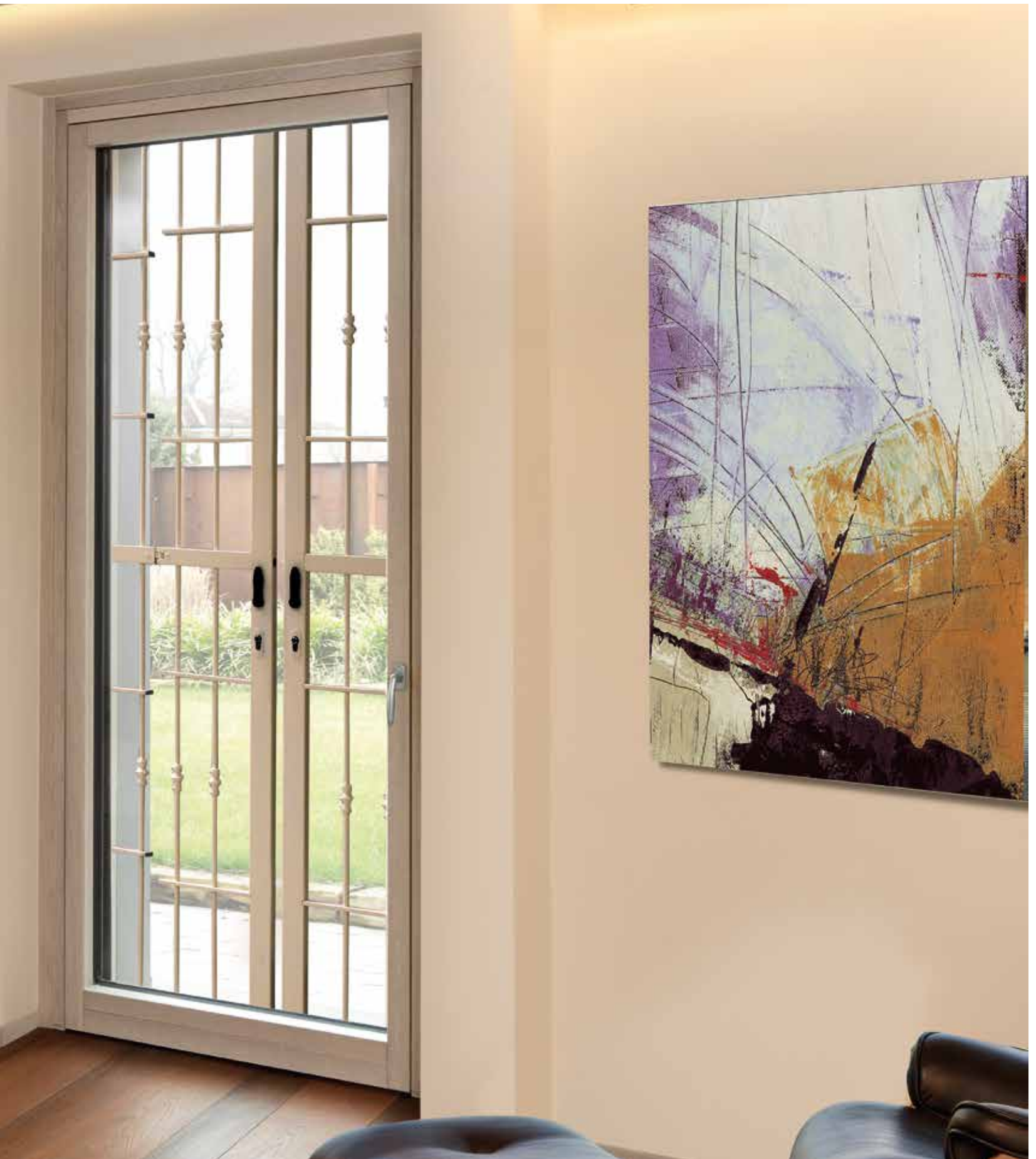

DEFENDER

SONO DISPONIBILI DIVERSI MODELLI MODULABILI CON VARI DECORI E ACCESSORI TECNICI PER SODDISFARE OGNI PIÙ PARTICOLARE ESIGENZA. LE COLORAZIONI DISPONIBILI SONO FRA OLTRE 30 FINITURE MARTELLATE E METALLIZZATE E TUTTE QUELLE DELLA TABELLA RAL.

Different models are available and they can be customized with different finishing and technical options to satisfy all the requests. The available colors are 30 hammering and metalized finishing and all available RAL colors.

Hay muchos modelos modulares con diferentes acabados y accesorios técnicos para encontrar cada necesidad. Los acabados se pueden elegir entre más de 30 colores martillados y metalizados y todos los colores RAL.

Les grilles sont disponibles en différents modèles, personnalisables avec plusieurs décors et optionnels techniques pour satisfaire toutes les exigences. Les couleurs disponibles sont les 30 finitions martelées et métallisées et tous les couleurs RAL.





DEFENDER

CERNIERE A SCOMPARSA DI SERIE E DUPLICE POSSIBILITÀ DI APERTURA: PARZIALE ALL'INTERNO DELL'AMBIENTE E TOTALE ALL'ESTERNO COMPLETAMENTE A RIDOSSO DEL SERRAMENTO E DELLA PERSIANA GRAZIE AD UN PRATICO SNODO DI DUE LUNGHEZZE DIFFERENTI.

Hidden Hinges as standard and double opening possibility: inside it can be opened partially whereas outside it can be opened totally next to window and the blind thanks to an easy junction of 2 different lengths.

Las bisagras son invisibles y hay una doble posibilidad de abertura parcial dentro el ambiente o completa a l'exterior contra la ventana o la persianas gracias a un cruce de dos largos diferentes.

Paumelles invisible comme standard et la double chance d'ouverture : partielle à l'intérieur et complète à l'extérieure jusqu'au près des fenêtres et ombres grâce à une pratique jonction des 2 différentes longueurs.





GRAZIE AL TAGLIO LASER, NEL MIGLIOR STILE ALIAS, LA LINEA È PRECISA E RIGOROSA E SI CONTRADDISTINGUE PER LA TOTALE ASSENZA DI SALDATURE A VISTA. TUTTI I PRODOTTI SONO PREDISPOSTI PER ACCOGLIERE UN SISTEMA DI ANTIFURTO WIRELESS.

Thank to laser cutting, as all Alias products, the line is strict and precise and it is featured by invisible welding. All the grates are set for the installation of a wireless alarm system.

Gracias al corte al laser, según el mejor estilo Alias, la línea es precisa y rigurosa sin soldaduras visibles. Todas las estructuras están preparadas para acoger un sistema antirrobo wireless.

Grace à la découpe laser dans le meilleur style Alias, la ligne est précise et rigoureuse et elle se caractérise par l'absence des soudures visibles. Tous les produits sont prédisposés pour l'installation d'un système d'alarme wireless.

DEFENDER



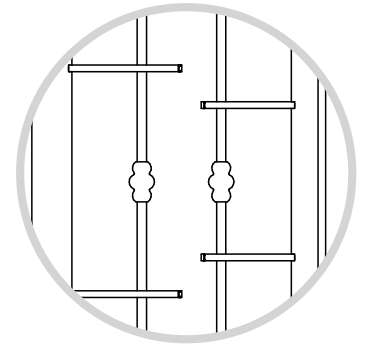
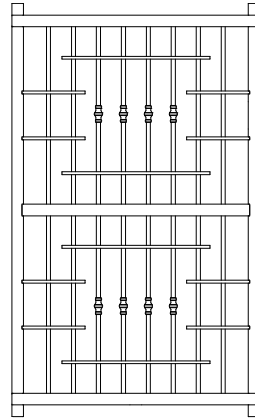
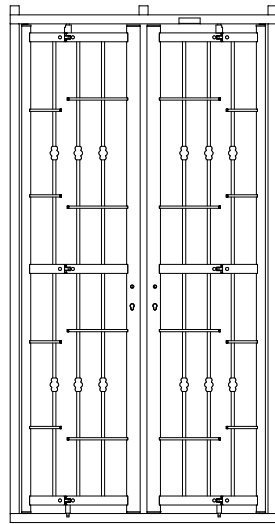
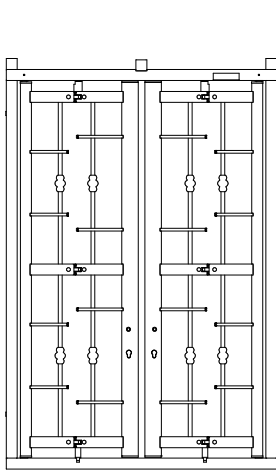

DEFENDER
D300

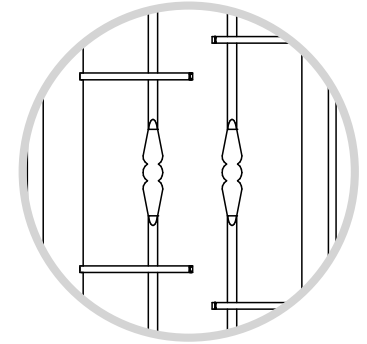
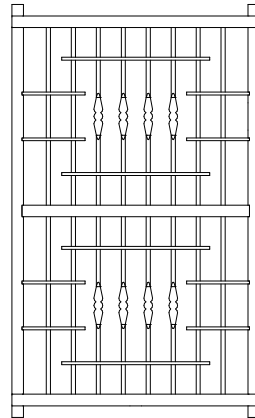
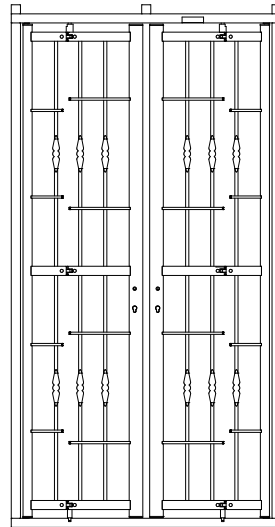
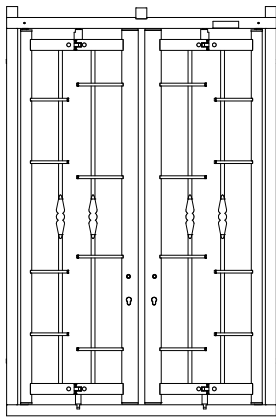

DEFENDER
D400

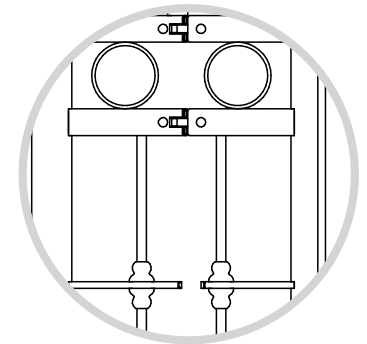
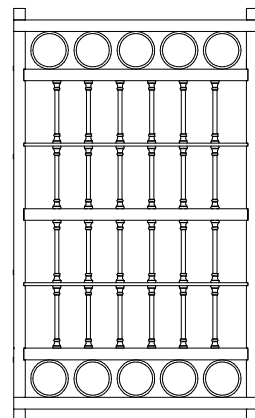
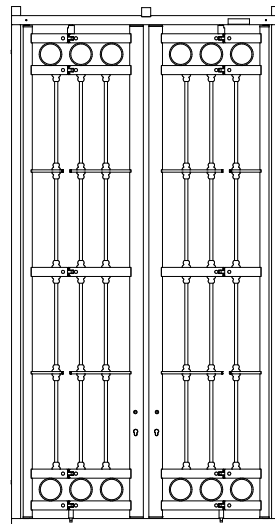
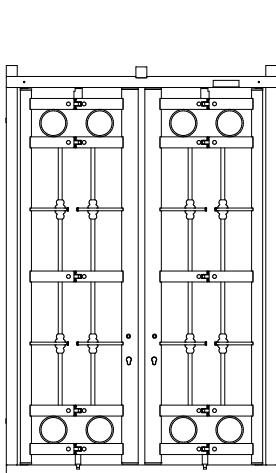

DEFENDER
D500

SCHEDA RILIEVO - MISURE GRATE

APPLICAZIONE CON SORMONTI VERTICALI E TUBOLARI LATERALI AGGIUNTIVI

Vista da interno

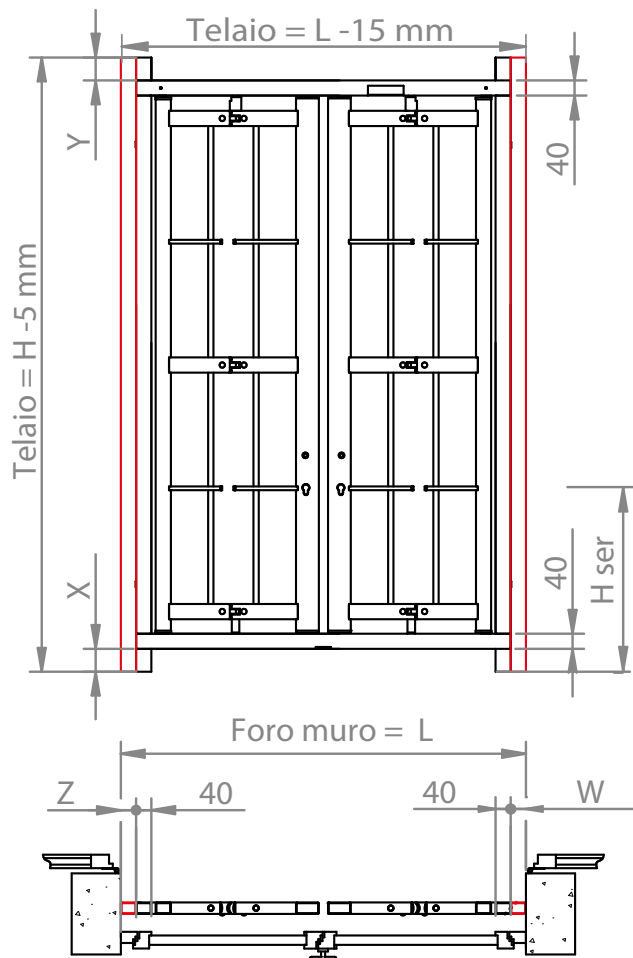

APPLICAZIONE STANDARD

Vista da interno

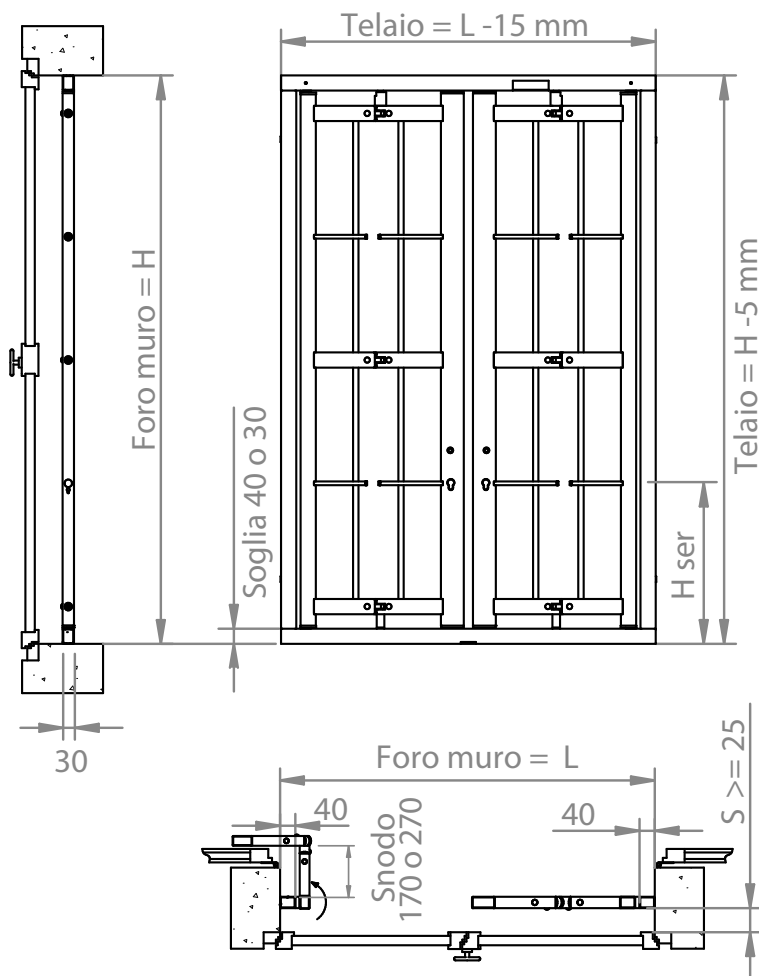

LEGENDA:

L: Luce orizzontale muro

H: Luce verticale muro

X: Sormonto telaio inferiore

Y: Sormonto telaio superiore

Z: Dimensione tubolare aggiuntivo SX

W: Dimensione tubolare aggiuntivo DX

S: Luce minima grata-serramento (>= 25 mm)

N.B.: in caso di porta finestra verificare se è presente una soglia a terra

SENSI DI APERTURA

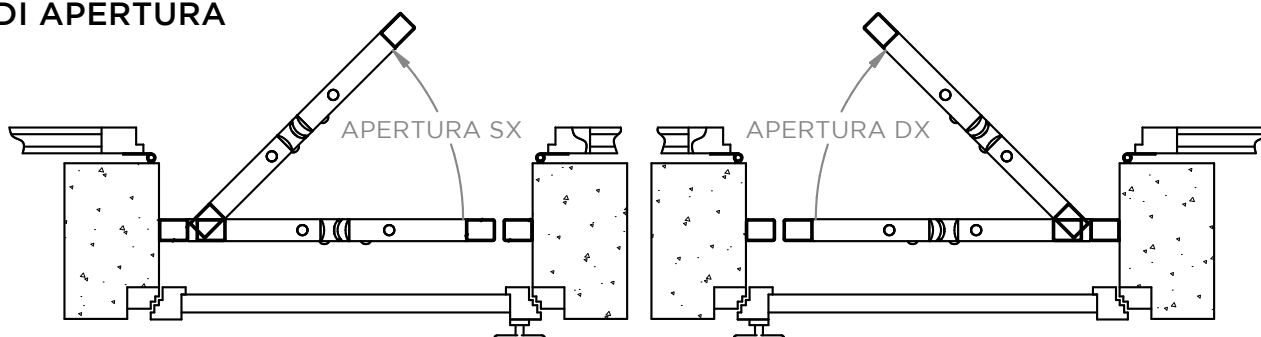

COLORI E FINITURE DISPONIBILI

AVAILABLE COLORS AND FINISHING
COULEURS ET FINITIONS DISPONIBLES
COLORES Y ACABADOS POSIBLES



COLORI RAL



VERDE RAL 6005 GRINZ



**MARRONE
TESTA DI MORO GRINZ**



BIANCO GLITTER



GRIGIO GLITTER



VERDE RAFFAELLO



MARRONE GLITTER



VERDE GLITTER

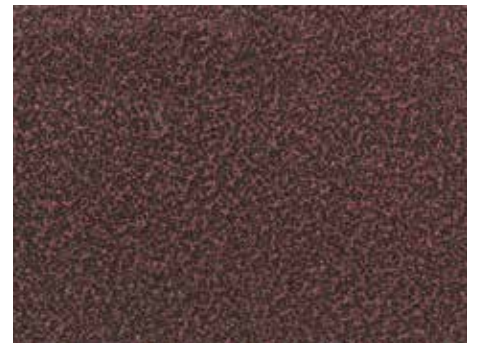

RAME MARTELLATO



RUGGINE



GRIGIO SABBIA

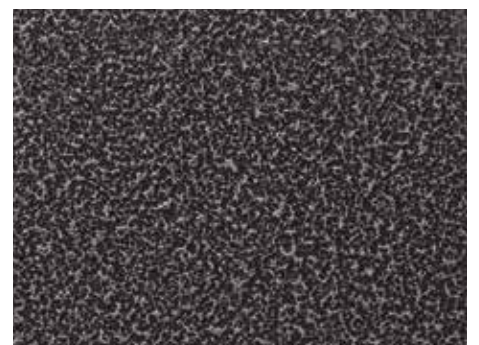

NERO MARTELLATO